

No warranty in case of non-compliance

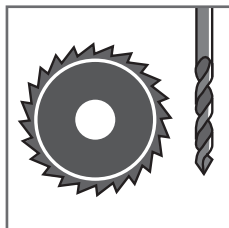

1 | Storage

Keep dry, flat and in its original packaging.



2 | Installation process

terraza profiles can be sawn, milled or drilled using all conventional types of wood-working tools.

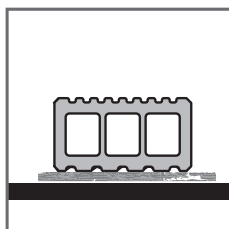

3 | Subframe

To be installed generally on rubber pads (for concrete surfaces) at individual points as load-bearers or on precast concrete slabs (for gravel beds or similar). Do not install directly on the ground, on soil or on grassed-over areas!

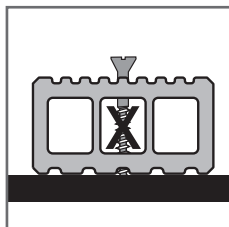

4 | Floating installation

As a general rule, the subframe must be laid as a floating structure (no rigid connection to the foundation). Exception: **Sub-framework edge bar**.

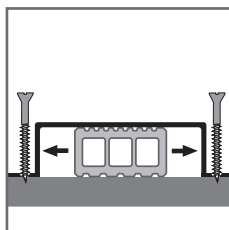

5 | Fastening of the sub-framework edge bars

All sub-framework edge bars must be affixed to the foundation with brackets. The brackets must be arranged such that the sub-framework edge bars can shift in all directions without restriction.

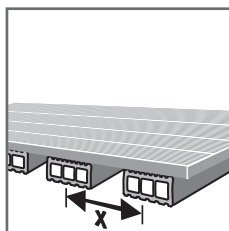

6 | Fixing clearances

$x = 600$ mm max.
Profile overhangs by 100 mm max.

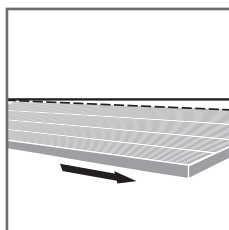

7 | Surface drainage

terraza profiles are to be laid at a gradient of at least 1.5–2% in the longitudinal direction. **Standing water in the profile cavities must absolutely be avoided!**

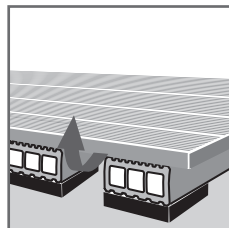

8 | Ventilation

There must be adequate air circulation underneath the surface.

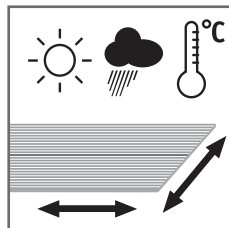

9 | Expansion

When laying terrazzo profiles, always allow an extra 6 mm/linear m max. in both length and width.

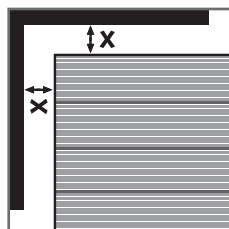

10 | Expansion joints

Maintain an expansion joint of $x =$ at least 20 mm or 3 mm/m on all sides for all wall stop ends.

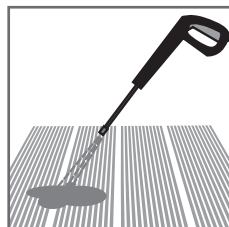

11 | Care + cleaning

Clean with warm water and household detergents. Oil and grease stains, etc., can be removed with Flash Express, a stain removal spray or other specialist surface cleaners.

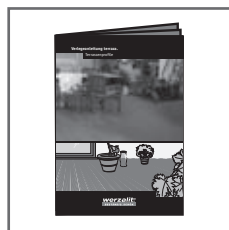

12 | Installation guidelines

Please make sure you read the detailed installation instructions for terrazzo profiles and/or tiles thoroughly. The most recent version is always available on the Internet (www.werzalit.com).



13 | Queries

WERZALIT UK Office
Lincoln LN2 3WN
Phone +44 (0) 1673/866 188
Fax +44 (0) 800/023 42 67
E-mail s.hill@werzalit.com
www.werzalit.com

werzalit[®]
LASTING. BEAUTY.

1a

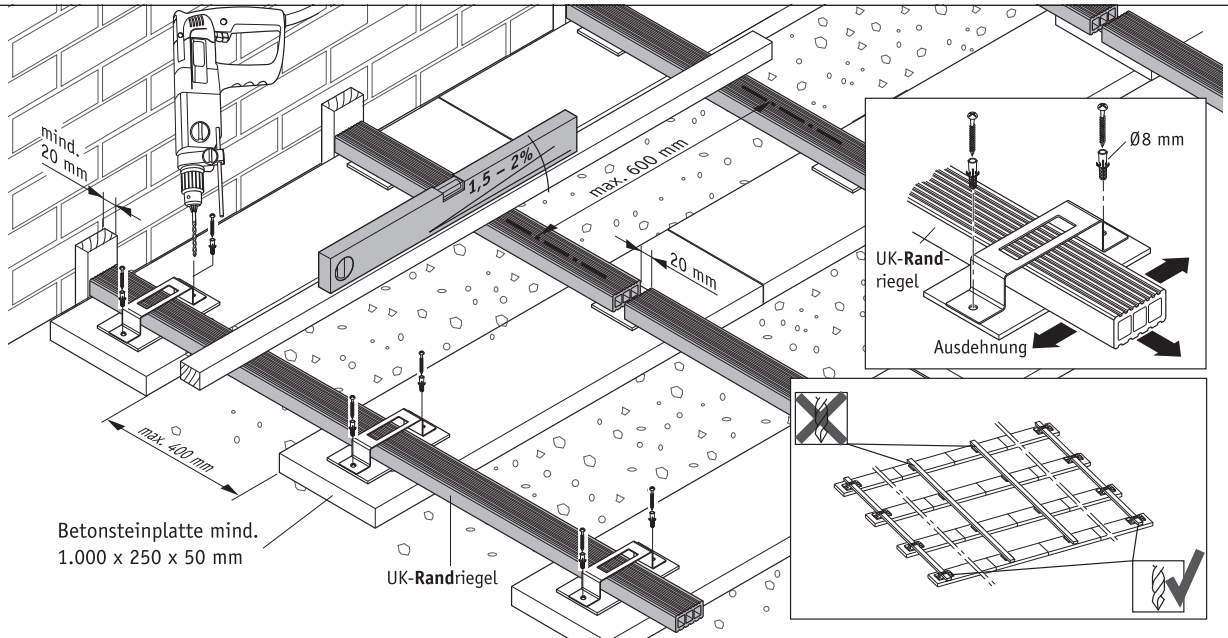

1b

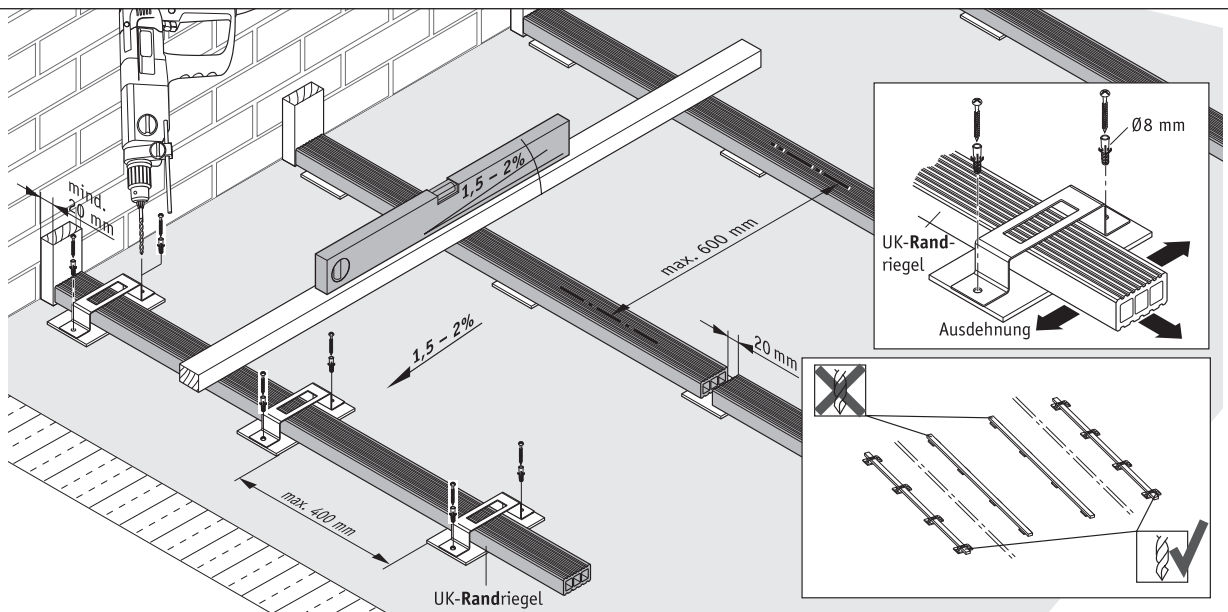

2

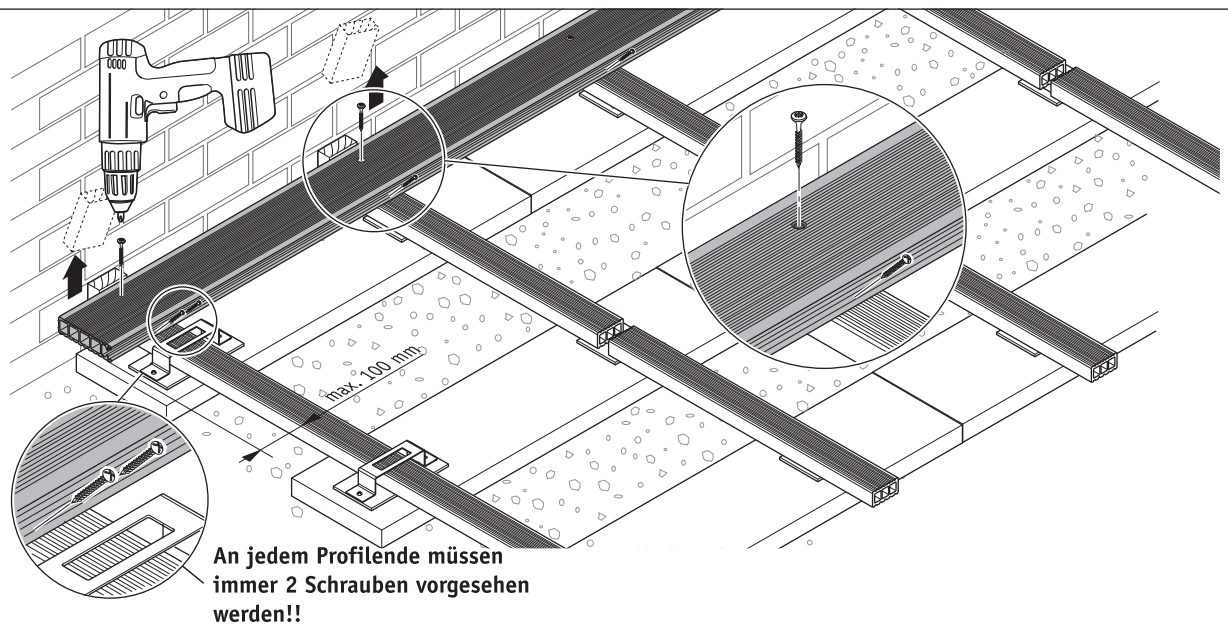

3

An jedem Profilende müssen
immer 2 Schrauben vorgesehen
werden!!

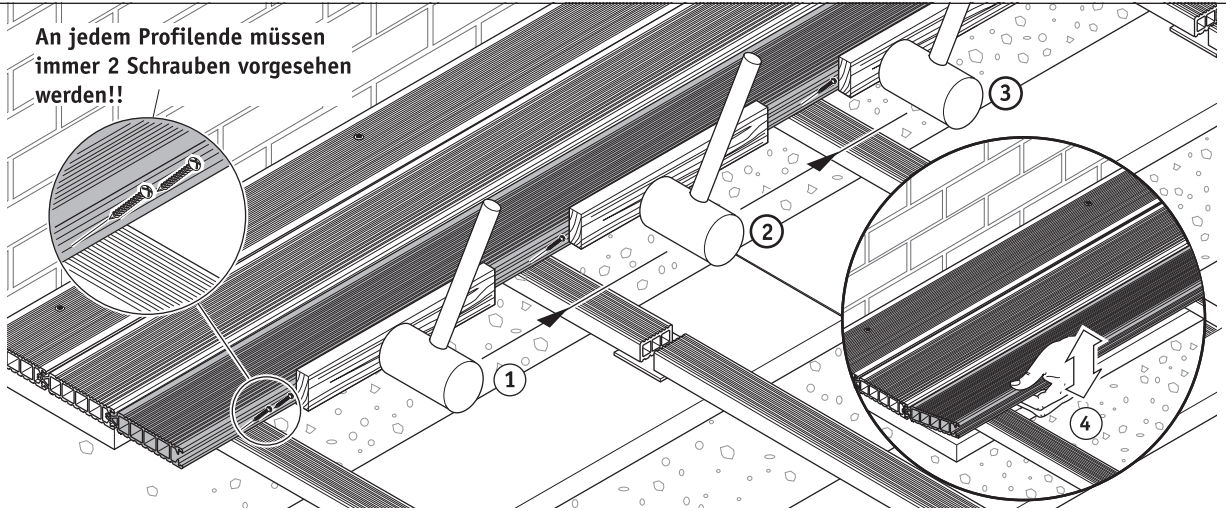

4

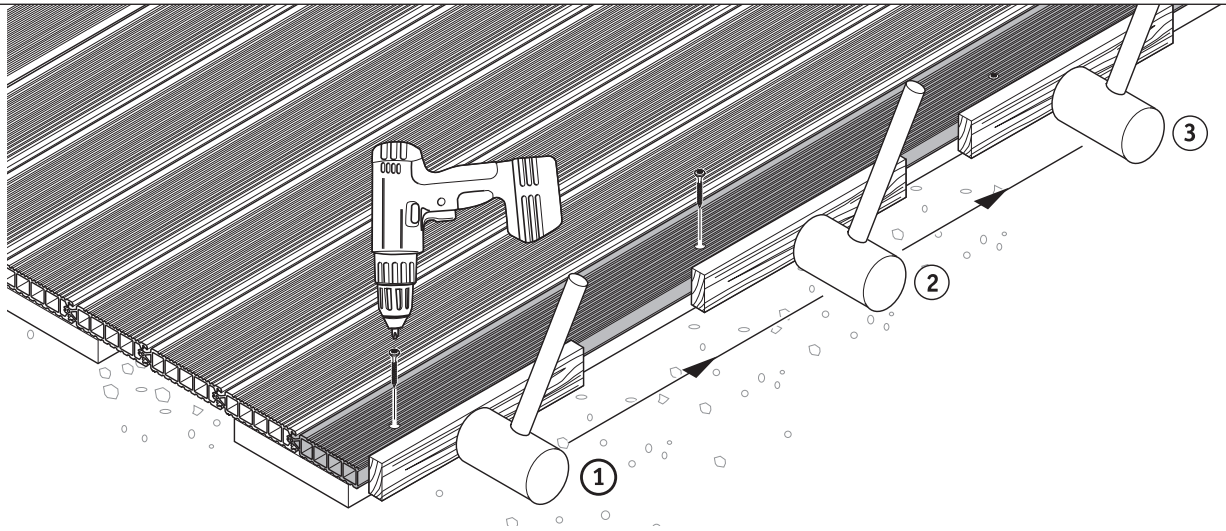

5

